

**Small Signal Product**

**5% Tolerance SMD Zener Diode**

**FEATURES**

- Wide zener voltage range selection: 2.4V to 75V
- VZ Tolerance Selection of ±5%
- Hermetically sealed glasses
- Moisture sensitivity level 1
- Matte Tin(Sn) lead finish with Nickel(Ni) underplate
- Pb free and RoHS compliant
- High reliability glass passivation insuring parameter stability and protection against junction contamination



**Mini-MELF (LL34)**

Hermetically Sealed Glass

**MECHANICAL DATA**

- Case: Mini-MELF Package (JEDEC DO-213AC)
- High temperature soldering guaranteed: 270°C/10s
- Polarity: Indicated by cathode band
- Weight: 31 mg (approximately)

MAXIMUM RATINGS AND ELECTRICAL CHARACTERISTICS (T <sub>A</sub> =25°C unless otherwise noted)			
PARAMETER	SYMBOL	VALUE	UNIT
Power Dissipation	P <sub>D</sub>	500	mW
Forward Voltage	I <sub>F</sub> = 10 mA	1	V
Thermal Resistance (Junction to Ambient)	(Note 1) R <sub>θJA</sub>	300	°C/W
Junction and Storage Temperature Range	T <sub>J</sub> , T <sub>STG</sub>	- 65 to +175	°C

Note1: Valid provided that electrodes are kept at ambient temperature

**Zener I vs. V Characteristics**

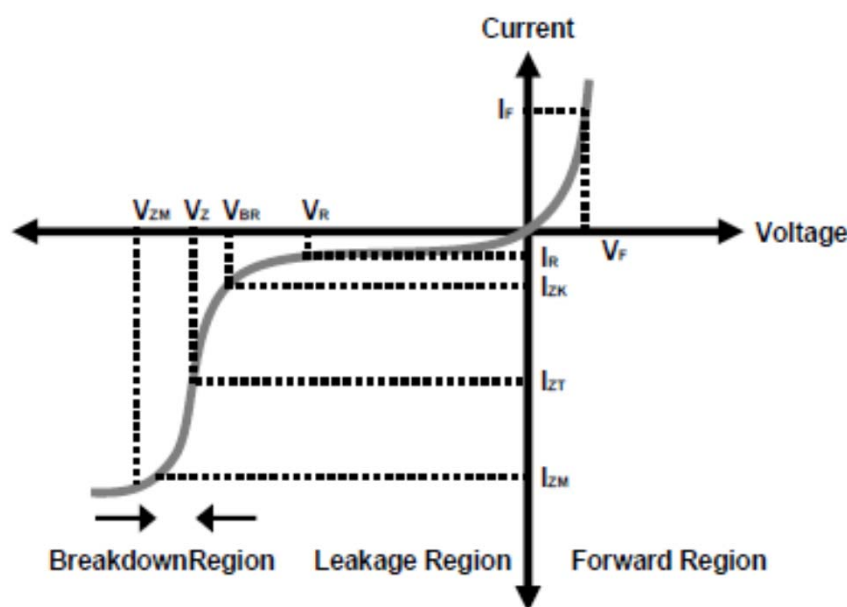

- V<sub>BR</sub> : Voltage at I<sub>ZK</sub>
- I<sub>ZK</sub> : Test current for voltage V<sub>BR</sub>
- Z<sub>ZK</sub> : Dynamic impedance at I<sub>ZK</sub>
- I<sub>ZT</sub> : Test current for voltage V<sub>Z</sub>
- V<sub>Z</sub> : Voltage at current I<sub>ZT</sub>
- Z<sub>ZT</sub> : Dynamic impedance at I<sub>ZT</sub>
- I<sub>ZM</sub> : Maximum steady state current
- V<sub>ZM</sub> : Voltage at I<sub>ZM</sub>

Small Signal

ELECTRICAL CHARACTERISTICS (  $T_A = 25^\circ\text{C}$  unless otherwise noted )

Part Number	$V_Z @ I_{ZT}$ (Volt)			$I_{ZT}$ (mA)	$Z_{ZT} @ I_{ZT}$ ( $\Omega$ ) Max	$I_{ZK}$ (mA)	$Z_{ZK} @ I_{ZK}$ ( $\Omega$ ) Max	$I_R @ V_R$ ( $\mu\text{A}$ ) Max	$V_R$ (V)
	Min	Nom	Max						
BZV55C2V4	2.28	2.4	2.56	5	85	1.0	600	50	1.0
BZV55C2V7	2.51	2.7	2.89	5	85	1.0	600	10	1.0
BZV55C3V0	2.8	3.0	3.2	5	85	1.0	600	4	1.0
BZV55C3V3	3.1	3.3	3.5	5	85	1.0	600	2	1.0
BZV55C3V6	3.4	3.6	3.8	5	85	1.0	600	2	1.0
BZV55C3V9	3.7	3.9	4.1	5	85	1.0	600	2	1.0
BZV55C4V3	4.0	4.3	4.6	5	75	1.0	600	1	1.0
BZV55C4V7	4.4	4.7	5.0	5	60	1.0	600	0.5	1.0
BZV55C5V1	4.8	5.1	5.4	5	35	1.0	550	0.1	1.0
BZV55C5V6	5.2	5.6	6.0	5	25	1.0	450	0.1	1.0
BZV55C6V2	5.8	6.2	6.6	5	10	1.0	200	0.1	2.0
BZV55C6V8	6.4	6.8	7.2	5	8	1.0	150	0.1	3.0
BZV55C7V5	7.0	7.5	7.9	5	7	1.0	50	0.1	5.0
BZV55C8V2	7.7	8.2	8.7	5	7	1.0	50	0.1	6.2
BZV55C9V1	8.5	9.1	9.6	5	10	1.0	50	0.1	6.8
BZV55C10	9.4	10	10.6	5	15	1.0	70	0.1	7.5
BZV55C11	10.4	11	11.6	5	20	1.0	70	0.1	8.2
BZV55C12	11.4	12	12.7	5	20	1.0	90	0.1	9.1
BZV55C13	12.4	13	14.1	5	26	1.0	110	0.1	10
BZV55C15	13.8	15	15.6	5	30	1.0	110	0.1	11
BZV55C16	15.3	16	17.1	5	40	1.0	170	0.1	12
BZV55C18	16.8	18	19.1	5	50	1.0	170	0.1	13
BZV55C20	18.8	20	21.1	5	55	1.0	220	0.1	15
BZV55C22	20.8	22	23.3	5	55	1.0	220	0.1	16
BZV55C24	22.8	24	25.6	5	80	1.0	220	0.1	18
BZV55C27	25.1	27	28.9	5	80	1.0	220	0.1	20
BZV55C30	28	30	32	5	80	1.0	220	0.1	22
BZV55C33	31	33	35	5	80	1.0	220	0.1	24
BZV55C36	34	36	38	5	80	1.0	220	0.1	27
BZV55C39	37	39	41	2.5	90	0.5	500	0.1	28
BZV55C43	40	43	46	2.5	90	0.5	600	0.1	32
BZV55C47	44	47	50	2.5	110	0.5	700	0.1	35
BZV55C51	48	51	54	2.5	125	0.5	700	0.1	38
BZV55C56	52	56	60	2.5	135	0.5	1,000	0.1	42
BZV55C62	58	62	66	2.5	150	0.5	1,000	0.1	47
BZV55C68	64	68	72	2.5	160	0.5	1,000	0.1	51
BZV55C75	70	75	80	2.5	170	0.5	1,000	0.1	56

Notes : 1. The zener Voltage ( $V_Z$ ) is tested under pulse condition of 10ms.

2. The device numbers listed have a standard tolerance on the nominal zener voltage of  $\pm 5\%$ .

3. For detailed information on price, availability and delivery of nominal zener voltages between the voltages shown and tighter voltage tolerances, contact your nearest Taiwan Semiconductor representative.

4. The zener impedance is derived from the 60-cycle ac voltage, which results when an ac current having an rms value equal to 10% of the dc zener current ( $I_{ZT}$  or  $I_{ZK}$ ) is superimposed to  $I_{ZT}$  or  $I_{ZK}$ .

**Small Signal Product**

**RATINGS AND CHARACTERISTICS CURVES**

(TA=25°C unless otherwise noted)

Fig. 1 Power Dissipation VS. Ambient Temperature

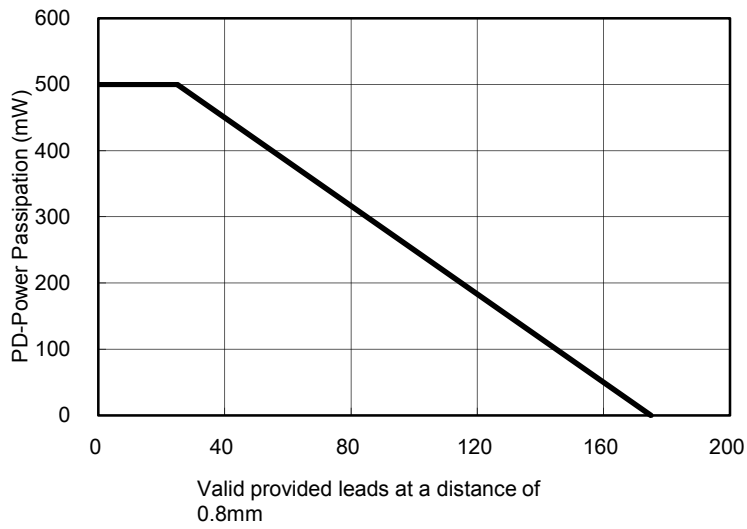

Fig. 2 Total Capacitance

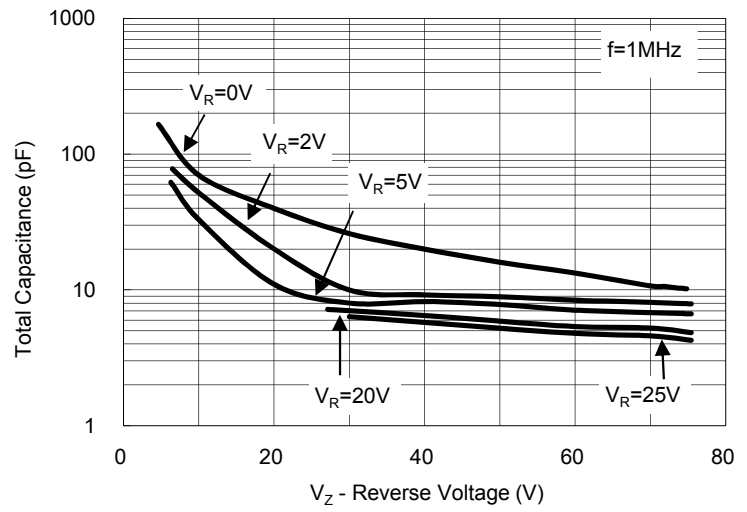

Fig. 3 Differential Impedance VS. Zener Voltage

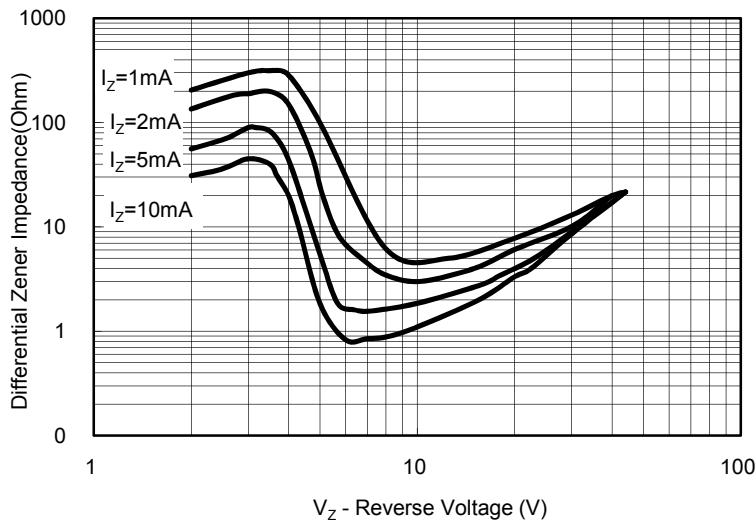

Fig. 4 Forward Current VS. Forward Voltage

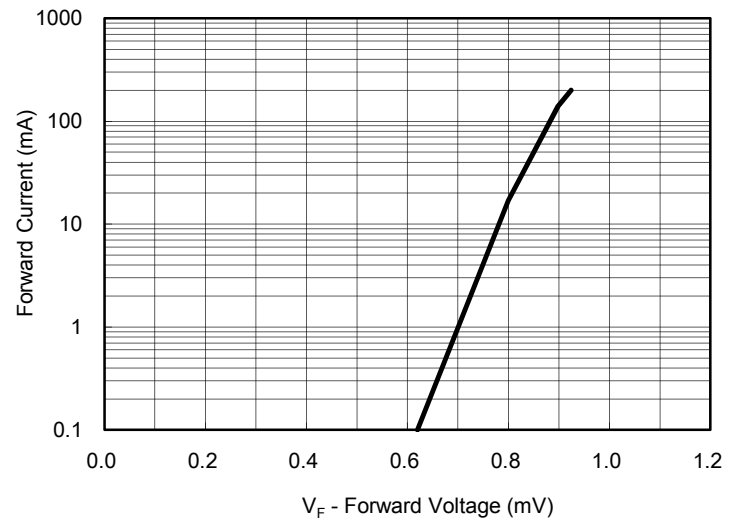

Fig. 5 Reverse Current VS. Reverse Voltage

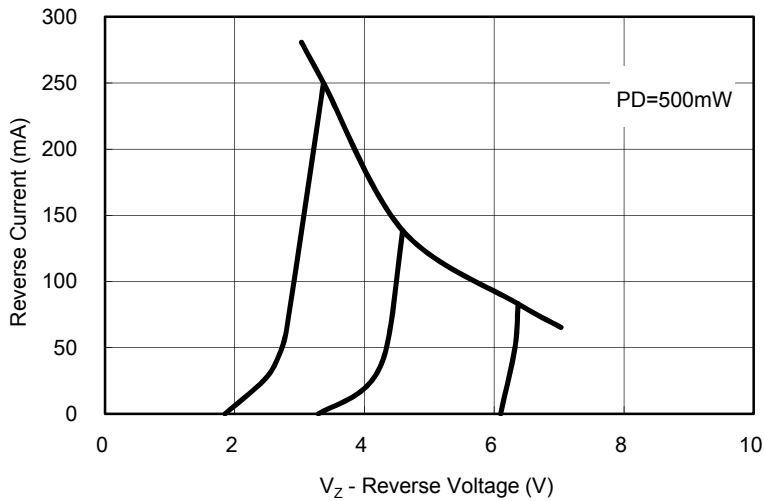
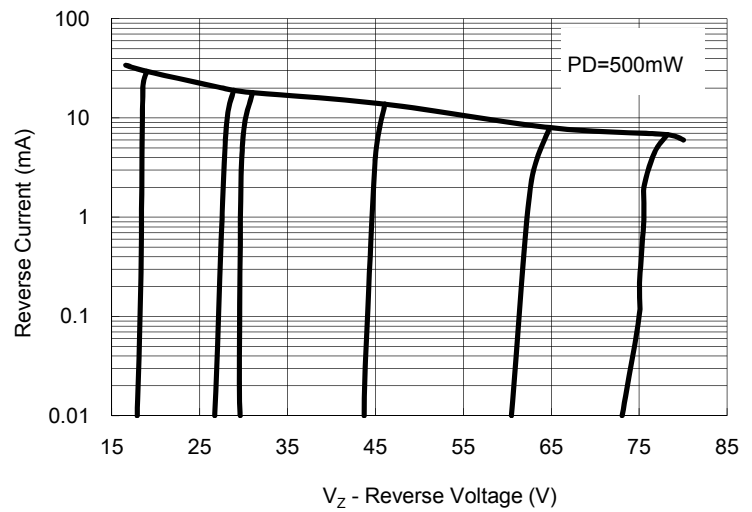

Fig. 6 Reverse Current VS. Reverse Voltage



Small Signal Product

ORDERING INFORMATION					
PART NO.	MANUFACTURE CODE	PACKING CODE	GREEN COMPOUND CODE	PACKAGE	PACKING
BZV55Cxxx (Note1)	(Note 2)	L0	G	LL34	10K / 13" Reel
		L1			2.5K / 7" Reel

Note 1: "xxx" defines voltage from 2.4V (BZV55C2V4) to 75V (BZV55C75)

Note 2: Manufacture special control, if empty means no special control requirement.

EXAMPLE					
PREFERRED P/N	PART NO.	MANUFACTURE CODE	PACKING CODE	GREEN COMPOUND CODE	DESCRIPTION
BZV55C75 L0G	BZV55C75		L0	G	Green compound
BZV55C75-L0 L0G	BZV55C75	L0	L0	G	Green compound
BZV55C75-B0 L0G	BZV55C75	B0	L0	G	Green compound

PACKAGE OUTLINE DIMENSION

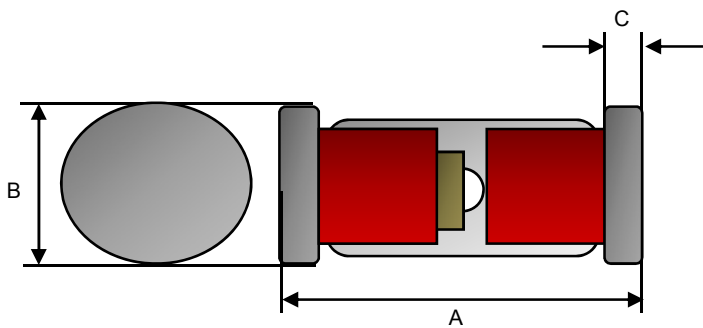

DIM.	Unit (mm)		Unit (inch)	
	Min	Max	Min	Max
A	3.30	3.70	0.130	0.146
B	1.40	1.60	0.055	0.063
C	0.20	0.50	0.008	0.020

SUGGEST PAD LAYOUT

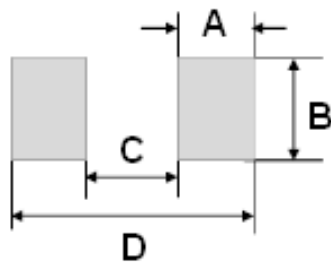

DIM.	Unit (mm)	Unit (inch)
	Typ.	Typ.
A	1.25	0.049
B	2.00	0.079
C	2.50	0.098
D	5.00	0.197

Small Signal Product

### Notice

Specifications of the products displayed herein are subject to change without notice. TSC or anyone on its behalf, assumes no responsibility or liability for any errors inaccuracies.

Information contained herein is intended to provide a product description only. No license, express or implied, to any intellectual property rights is granted by this document. Except as provided in TSC's terms and conditions of sale for such products, TSC assumes no liability whatsoever, and disclaims any express or implied warranty, relating to sale and/or use of TSC products including liability or warranties relating to fitness for a particular purpose, merchantability, or infringement of any patent, copyright, or other intellectual property right.

The products shown herein are not designed for use in medical, life-saving, or life-sustaining applications. Customers using or selling these products for use in such applications do so at their own risk and agree to fully indemnify TSC for any damages resulting from such improper use or sale.